

MC3330R

RFID Handheld



ZEBRA

Quick Reference Guide

for Android™ 7.1.2 Nougat

Warranty

For the complete Zebra hardware product warranty statement, go to:
www.zebra.com/warranty.

Service Information

If you have a problem using the equipment, contact your facility's Technical or Systems Support. If there is a problem with the equipment, they will contact the Zebra Support at: www.zebra.com/support.

For the latest version of this guide go to: www.zebra.com/support.

Software Support

Zebra wants to ensure that customers have the latest release of entitled software at the time of product purchase.

To confirm that your Zebra device shipped with the latest release of entitled software, visit: www.zebra.com/support. Check for the latest software from: Software Downloads > Product Line/Product > Go.

If your device does not have the latest entitled software release as of your product purchase date, please e-mail a request to Zebra at: entitlementservices@zebra.com.

You must include the following essential device information with your request:

- Model number
- Serial number
- Proof of purchase
- Title of the software download you are requesting.

If it is determined by Zebra that your device is entitled to the latest software release, you will receive an e-mail containing a link directing you to a Zebra web site to download the appropriate software.

Related Information

The following documents provide more information about the RFID reader:

- MC3300R Integration Guide Supplement (p/n MN-003180-xx)
- Zebra RFID SDK for Android Developer Guide (p/n MN-003158-xx)

For the latest version of this guide and all guides, go to:
www.zebra.com/support.

MC3330R Features

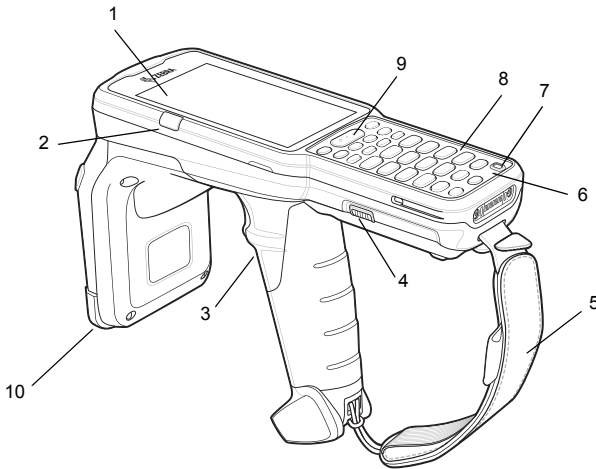

Item	Description
1	Display - Displays all information needed to operate the MC3330R.
2	Charge LED Scan/Decode Status - Indicates the battery charge state while charging or the scan/decode status.
3	Trigger - Initiates data capture when a scan application is enabled.
4	Battery Release Latch - Release the battery from the device.
5	Hand Strap - Use for securely holding the device.
6	Microphone - Use for communications in Handset mode.
7	<p>Power Button - Press and hold to turn on the MC3330R. Press to turn on or off the screen. Press and hold to select one of these options:</p> <p>Power off - Turn off the device.</p> <p>Reboot - Reboot the device when software stops responding.</p> <p>Airplane mode - Disable all wireless connections.</p> <p>Silent mode - All notifications are disabled except for alarms.</p>

Item	Description
8	Keypad - Use to enter data and navigate on screen functions.
9	Scan Button - Initiates data capture when a scan application is enabled.
10	RFID Module.

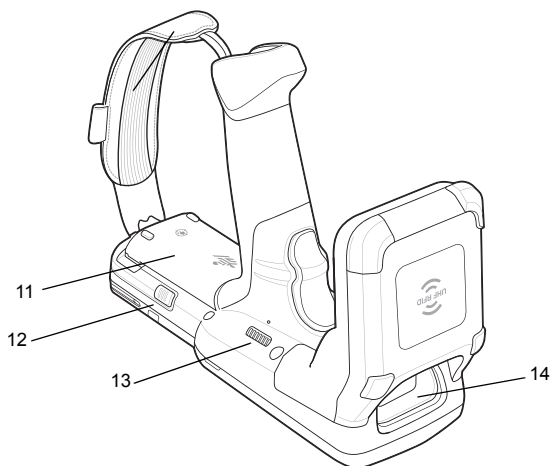

Item	Description
11	Battery - Provides power for operating the device.
12	Battery Release Latch - Release the battery from the device.
13	Speaker - Provides audio output for video and music playback.
14	Scanner Exit Window - Provides data capture using the scanner.

Setup

To start using the MC3330R for the first time:

- Install a microSD card (optional)
- Install the battery
- Charge the MC3330R
- Power on the MC3330R.

Installing a microSD Card

The microSD card slot provides secondary non-volatile storage. The slot is located under the battery pack. Refer to the documentation provided with the card for more information, and follow the manufacturer's recommendations for use.



CAUTION Follow proper electrostatic discharge (ESD) precautions to avoid damaging the microSD card. Proper ESD precautions include, but are not limited to, working on an ESD mat and ensuring that the operator is properly grounded.

1. Using a coin or finger, remove the microSD card cover.

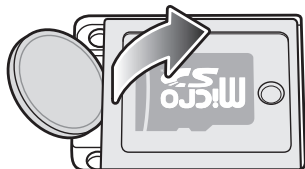

2. Slide the microSD card holder to the Open position.

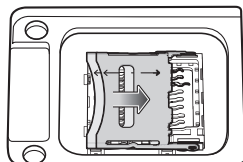

3. Lift the microSD card holder.

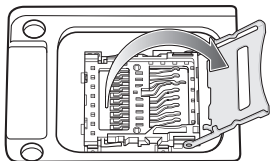

4. Place the microSD card into the contact area with the contacts facing down.

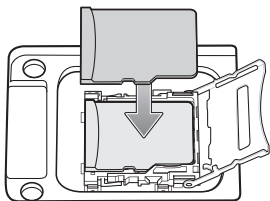

5. Close the microSD card holder and slide the microSD card holder to the Lock position.

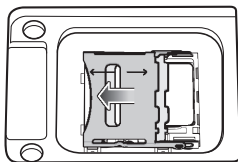
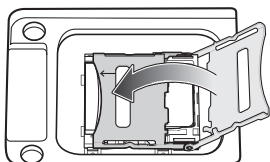

6. Replace the microSD card cover and ensure that it is installed properly.

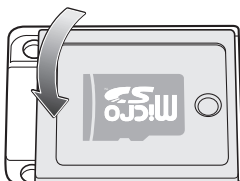
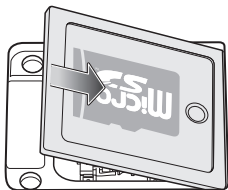

Installing the MC3330R Battery

To install the battery:

1. Align the battery into the battery compartment.

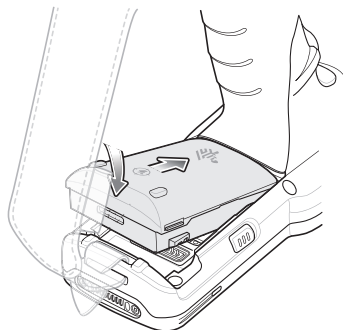

2. Rotate the bottom of the battery into the battery compartment.
3. Press battery down firmly. Ensure that both battery release buttons on the sides of the MC3330R return to the home position.

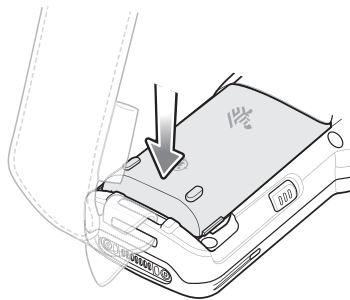

4. Press the Power button to turn on the device.

Replacing the Battery

1. Push in the two Battery Release buttons.

The battery ejects slightly. With Hot Swap mode, when the user removes the battery, the display turns off and the device enters a low power state. The MC3330R retains RAM data for approximately five minutes. Replace the battery within five minutes to preserve memory persistence.

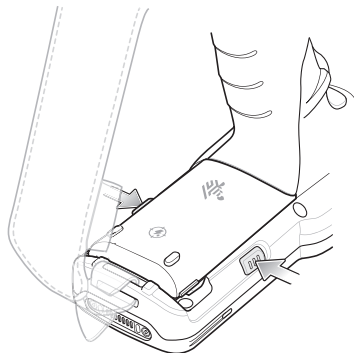

2. Remove the battery from the battery compartment.

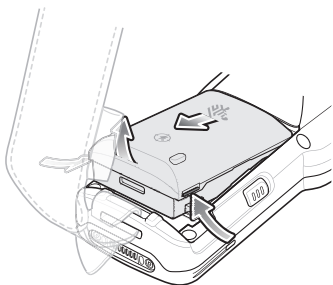

3. Align the battery into the battery compartment.

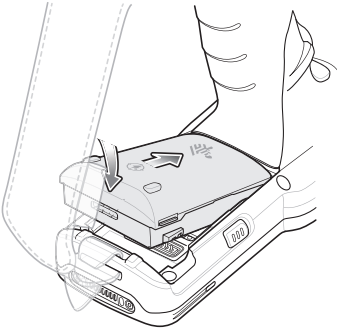

4. Rotate the bottom of the battery into the battery compartment.
5. Press battery down firmly. Ensure that both battery release buttons on the sides of the MC3330R return to the home position.

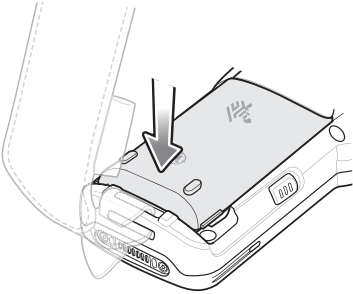

6. Press the Power button to turn on the device.

Compatibility

The table below displays compatibility between MC3330R and MC32N0 mobile computers and accessories.

	MC3330R PP+ Batteries	MC32N0 PP Batteries	MC3330R Cradles	MC32N0 Cradles	MC3330R Battery Charger	MC32N0 Battery Charger
MC3330R mobile computer	Yes	Yes	Yes	Yes w/adapter	N/A	N/A
MC32N0 mobile computer	No	Yes	No	Yes	N/A	N/A
MC3330R PP+ Battery	N/A	N/A	Yes	No	Yes	No
MC32N0 PP Battery	N/A	N/A	Yes	Yes	Yes	Yes

- MC3330R mobile computers are compatible with all batteries (MC3330R PowerPrecision+ and MC32N0 PowerPrecision).
- MC3330R mobile computer is compatible with all cradles.
- An additional adapter is needed to use any MC32N0 cradle slot, which provides charge only, no communication.
- MC3330R battery charger slots are compatible with all batteries (MC3330R PowerPrecision+ and MC32N0 PowerPrecision).
- MC32N0 mobile computers are not compatible with MC3300R cradles.

Battery Comparison

The table below displays a comparison of the MC3330R batteries with the MC32N0 batteries.

Feature	MC32N0	MC3330R
Battery Type	PowerPrecision	PowerPrecision+
Includes Zebra and PowerPrecision+ recessed logos	No	Yes
Back Label	Grey	Blue

Battery Compatibility

- MC3330R PowerPrecision+ batteries are compatible with all MC3300R mobile computers and accessories.
- MC3330R PowerPrecision+ batteries are not compatible with MC32N0 mobile computers and accessories.
- MC32N0 PowerPrecision batteries are compatible with all MC32N0 mobile computers and accessories.
- MC32N0 PowerPrecision batteries are compatible with all MC3300R mobile computers and accessories.

Charging the MC3330R

Use one of the following accessories to charge the MC3330R and/or spare battery.

Description	Part Number	Charging		Communication	
		Battery (In Device)	Spare Battery	USB	Ethernet
1-Slot USB Charge Cradle with Spare Battery Charger	CRD-MC33-2SUCHG-01	Yes	Yes	Yes	No
5-Slot Charge Only ShareCradle	CRD-MC33-5SCHG-01	Yes	No	No	No
5-Slot Ethernet ShareCradle	CRD-MC33-5SETH-01	Yes	No	No	Yes
4-Slot Charge ShareCradle with 4-Slot Battery Charger	CRD-MC33-4SC4BC-01	Yes	Yes	No	No
4-Slot Ethernet ShareCradle with 4-Slot Battery Charger	CRD-MC33-4SE4BC-01	Yes	Yes	No	Yes
4-Slot Spare Battery Charger	SAC-MC33-4SCHG-01	No	Yes	No	No
20-Slot Spare Battery Charger	SAC-MC33-20SCHG-01	No	Yes	No	No
USB Charge Cable	CBL-MC33-USBCHG-01	Yes	No	Yes	No
MC32N0 1-Slot Cradle with MC33XX Cradle Adapter	CRD3000-1001RR ADP-MC33-CRDUCUP-01	Yes	Yes (Only charges MC32N0 batteries in the spare battery slot)	Yes	No

- To charge the main battery, connect the charging accessory to the appropriate power source.
- Insert the MC3330R into a cradle or attach to a cable. The MC3330R turns on and begins charging. The Charging/Notification LED remains amber while charging, then turns solid green when fully charged.

Charging Temperature

Charge batteries in temperatures from 0°C to 40°C (32°F to 104°F). The device or cradle always performs battery charging in a safe and intelligent manner. At higher temperatures (e.g. approximately +37°C (+98°F)) the device or cradle may, for small periods of time, alternately enable and disable battery charging to keep the battery at acceptable temperatures. The device and cradle indicate when charging is disabled due to abnormal temperatures via its LED.

Charging the Spare Battery

1. Insert a spare battery into the spare battery slot.
2. Ensure the battery is seated properly.

The Spare Battery Charging LED blinks indicating charging. See below for charging indicators.

State	Indication
Off	The battery is not charging. The battery is not inserted correctly in the cradle or connected to a power source. Cradle is not powered.
Slow Blinking Amber Every 3 Seconds	Battery is charging, but the battery is fully depleted and does not yet have sufficient charge to power the device.
Solid Amber	Battery is charging.
Solid Green	Battery charging is complete.
Fast Blinking Red 2 Blinks/Second	Charging error, for example: Temperature is too low or too high. Charging has gone on too long without completion (typically eight hours).
Solid Red	Spare battery is charging and battery is at the end of useful life. Charging complete and battery is at the end of useful life.

1-Slot USB Charge Cradle

The 1-Slot USB Charge Cradle:

- Provides 9 VDC power for charging the mobile computer and charging the battery.
- Provides 4.2 VDC power to charge the spare battery.
- Provides a USB port for data communication between the mobile computer and a host computer or other USB devices (e.g., a printer).
- Synchronizes information between the mobile computer and a host computer. With customized or third party software, it can also synchronize the mobile computer with corporate databases.
- Compatible with the following batteries:
 - MC3330R 5200 mAh PowerPrecision+ extended battery.
 - MC32N0 5200 mAh PowerPrecision extended battery.

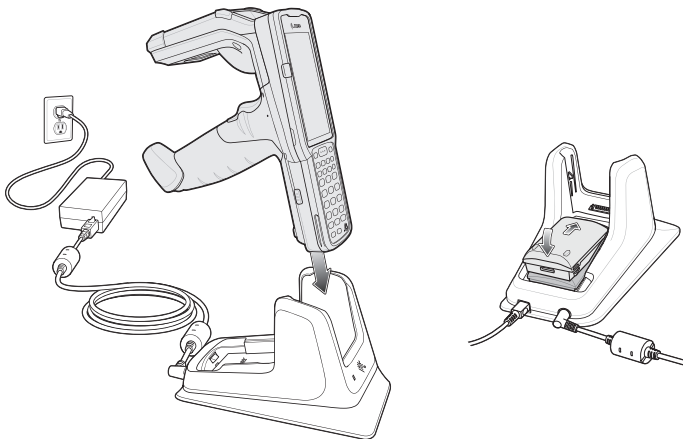

5-Slot Charge Only ShareCradle

The 5-Slot Charge Only ShareCradle:

- Provides 9 VDC power for operating the mobile computer and charging the battery.
- Simultaneously charges up to five mobile computers.
- Compatible with devices using the following batteries:
 - MC3330R 5200 mAh PowerPrecision+ extended battery.
 - MC32N0 5200 mAh PowerPrecision extended battery.

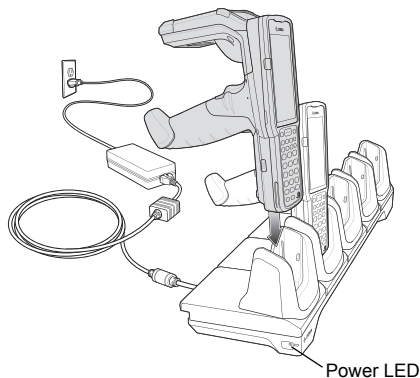

5-Slot Ethernet ShareCradle

The 5-Slot Ethernet ShareCradle:

- Provides 9 VDC power for operating the mobile computer and charging the battery.
- Simultaneously charges up to five mobile computers.
- Compatible with devices using the following batteries:
 - MC3330R 5200 mAh PowerPrecision+ extended battery.
 - MC32N0 5200 mAh PowerPrecision extended battery.

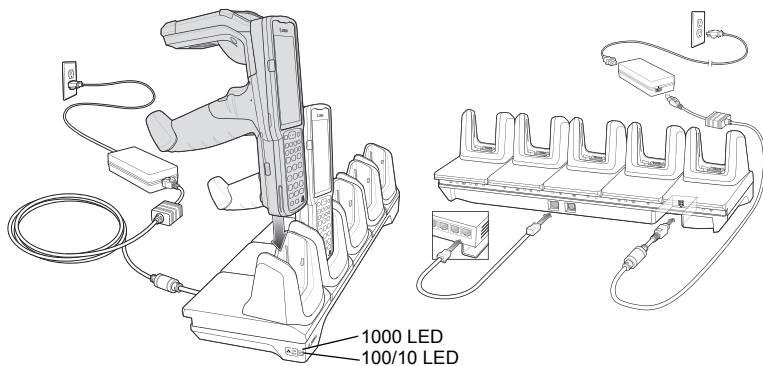

4-Slot ShareCradle with 4-Slot Battery Charger

The 4-Slot ShareCradle with 4-Slot Battery Charger:

- Provides 9 VDC power for operating the mobile computer and charging the battery.
- Provides 4.2 VDC power for charging spare batteries.
- Simultaneously charges up to four mobile computers and four spare batteries.
- Compatible with the following batteries:
 - MC3330R 5200 mAh PowerPrecision+ extended battery.
 - MC32N0 5200 mAh PowerPrecision extended battery.

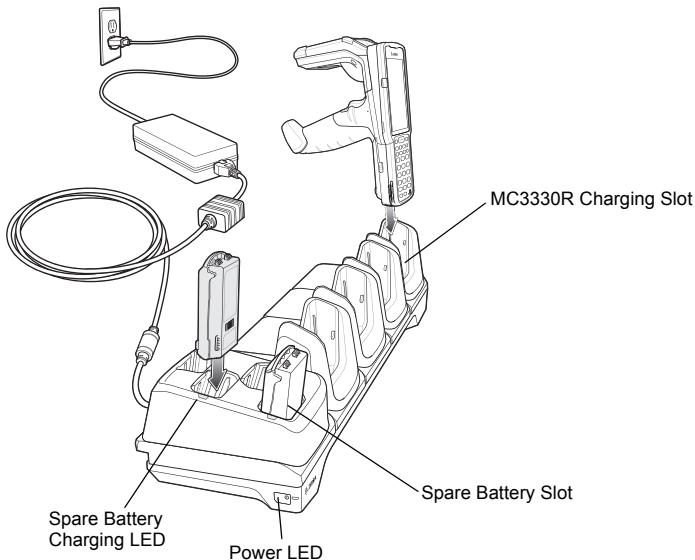

4-Slot Ethernet ShareCradle with 4-Slot Battery Charger

The 4-Slot Ethernet ShareCradle with 4-Slot Battery Charger:

- Provides 9 VDC power for operating the mobile computer and charging the battery.
- Provides 4.2 VDC power for charging spare batteries.
- Simultaneously charges up to four mobile computers and four spare batteries.
- Compatible with the following batteries:
 - MC3330R 5200 mAh PowerPrecision+ extended battery.
 - MC32N0 5200 mAh PowerPrecision extended battery.

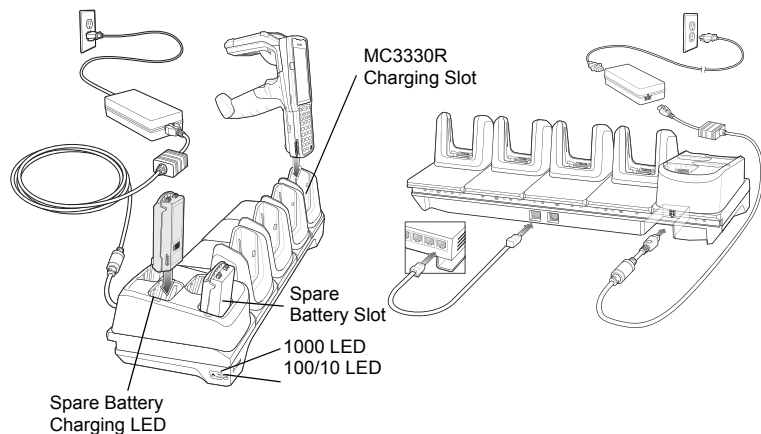

4-Slot Spare Battery Charger

The 4-Slot Battery Charger:

- Charges up to four MC3330R spare batteries.
- Provides 4.2 VDC power to charge the spare battery.
- Compatible with the following batteries:
 - MC3330R 5200 mAh PowerPrecision+ extended battery.
 - MC32N0 5200 mAh PowerPrecision extended battery.

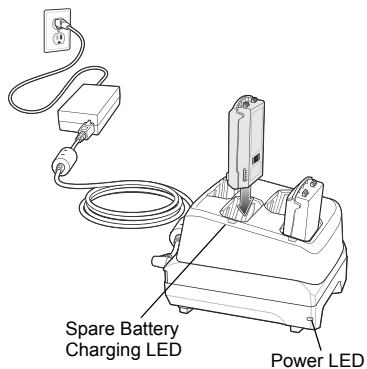

20-Slot Spare Battery Charger

The 20-Slot Battery Charger:

- Charges up to twenty MC3330R spare batteries.
- Provides 4.2 VDC power to charge the spare battery.
- Compatible with the following batteries:
 - MC3330R 5200 mAh PowerPrecision+ extended battery.
 - MC32N0 5200 mAh PowerPrecision extended battery.

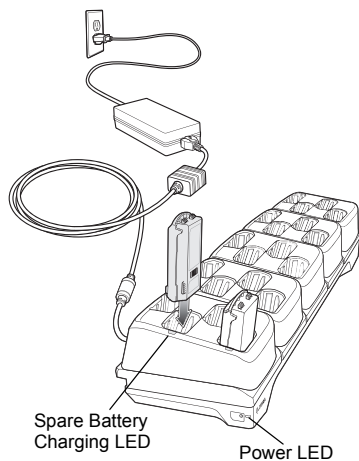

USB Charge Cable

The USB Charge Cable:

- Provides 5 VDC power to charge the battery.
- Provides power and/or communication with the host computer over USB to the device.
- Compatible with devices using the following batteries:
 - MC3330R 5200 mAh PowerPrecision+ extended battery.
 - MC32N0 5200 mAh PowerPrecision extended battery.

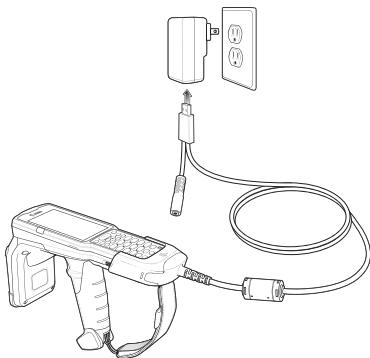
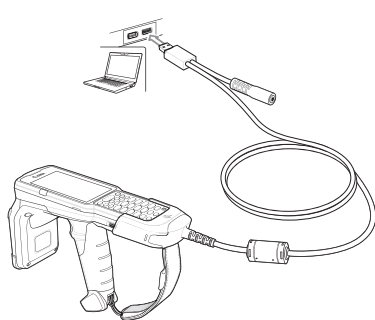
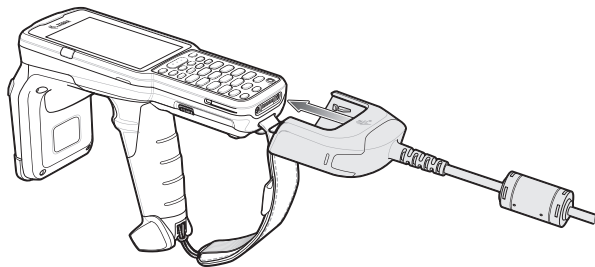

MC33XX Charge Only Adapter

Use the MC33XX Charge Only Adapter for backwards compatibility with the MC32N0 cradles and the MC3330R mobile computer.

- MC33XX Charge Only Adapter supports the MC32N0 1-Slot USB Cradle, MC32N0 4-Slot Charge Only Cradle, and MC32N0 4-Slot Ethernet Cradle.
- MC33XX Charge Only Adapter provides charge only; no communication when used with the MC32N0 cradles.
- MC32N0 1-Slot USB Cradle provides 5.4 VDC to charge the device.
- MC32N0 1-Slot USB Cradle (with the MC33XX Charge Only Adapter) is compatible with an MC3330R mobile computer charging either an MC3330R PowerPrecision+ extended battery or an MC32N0 PowerPrecision extended battery, but the MC32N0 1-Slot USB Cradle spare battery slot is only compatible with the MC32N0 PowerPrecision batteries.

MC33XX Charge Only Adapter Installation

To install the MC33XX Charge Only Adapter:

1. Clean the MC32N0 cradle and contacts with an alcohol wipe, using a back and forth motion with your finger.

For more information about cleaning, refer to the Maintenance and Troubleshooting chapter of the MC33XX Mobile Computer User Guide.

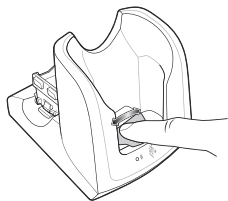

2. Peel and remove the adhesive from the back of the adapter.

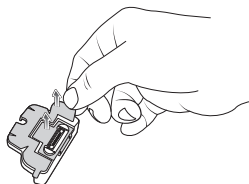

3. Insert the adapter into the MC32N0 cradle and adhere to the bottom of the cradle.

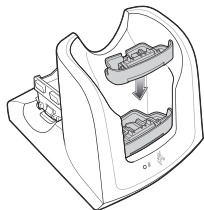

4. Insert the MC3330R device into the MC32N0 cradle.

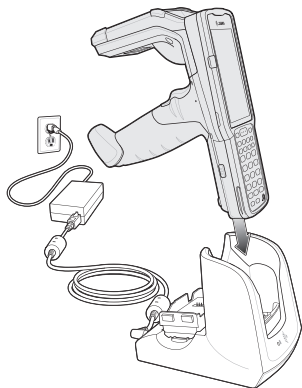

Scanning

The MC3330R offers the following data capture option: SE4750-SR 2D Imager.

Barcode Capture with Imager

To capture barcode data:

1. Ensure that an application is open on the device and a text field is in focus (text cursor in text field).
2. Point the top of the device at a barcode.
3. Press and hold the Scan button or Trigger.

The red laser aiming pattern turns on to assist in aiming.

4. Ensure the barcode is within the area formed by the cross-hairs in the aiming pattern. The aiming dot is used for increased visibility in bright lighting conditions.

The Scan LEDs light green and a beep sounds, by default, to indicate the barcode decoded successfully.

- ✓ **NOTE** Scan aiming pattern may look different depending on the scanner configuration.

When the device is in Pick List Mode, the device does not decode the barcode until the center of the crosshair touches the barcode.

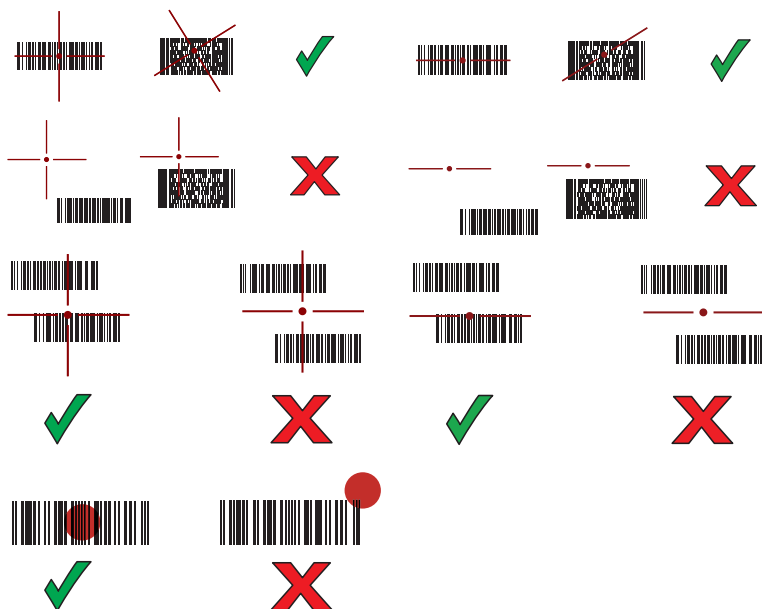

5. Release the scan button or Trigger.
6. The barcode content data appears in the text field.

Optimum RFID Tag Decoding

To read RFID tags:

1. Use an RFID reader application to enable tag reading. For a sample application, tap on the **RFID Reader** icon.
2. Point the device at the tag, oriented horizontally or vertically depending on the tag orientation. The distance between the tag and the antenna is the approximate read range.
3. Press the trigger or tap the on-screen Read command within the application to interrogate all RFID tags within the radio frequency (RF) field of view and capture data from each new tag found.
4. Release the trigger or tap the Stop Read command to stop interrogating tags.

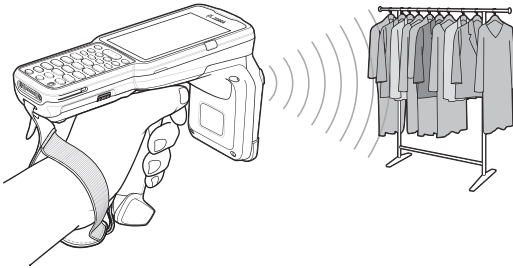

Ergonomic Considerations

Taking breaks and task rotation is recommended.

Optimize Body Posture for Upright Scanning



Optimize Body Posture for Low Scanning

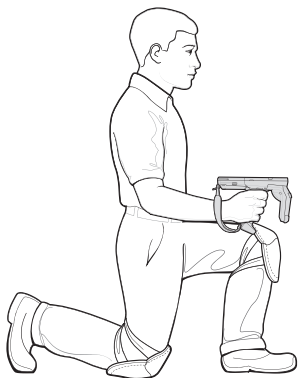

Alternate left and right knees.

Optimize Body Posture for High Scanning



Alternate left and right hand.

Avoid Bending



Avoid Reaching

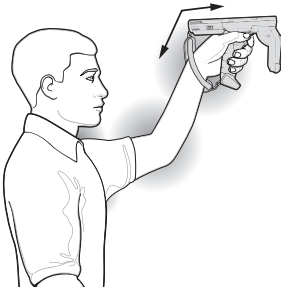

Avoid Extreme Wrist Angles

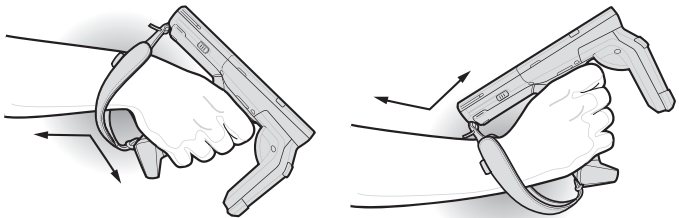

Regulatory Information

This device is approved under Zebra Technologies Corporation.

This guide applies to Model Number MC3300R.

All Zebra devices are designed to be compliant with the rules and regulations in the locations they are sold and will be labeled as required.

Local language translations are available at the following website:
www.zebra.com/support.

Any changes or modifications to Zebra equipment not expressly approved by Zebra could void the user's authority to operate the equipment.

Declared maximum operating temperature: 50°C.



CAUTION Only use approved and UL Listed accessories, battery packs and battery chargers.

Do NOT attempt to charge damp/wet mobile computers or batteries. All components must be dry before connecting to an external power source.

Bluetooth® Wireless Technology

This is an approved Bluetooth® product. For more information or to view the End Product Listing, please visit www.bluetooth.org/tpg/listings.cfm.

Wireless Devices Country Approvals

Regulatory markings subject to certification are applied to the device signifying the radio(s) is/are approved for use in the following countries and continents: United States, Canada, Japan, China, South Korea, Australia, and Europe¹.

Please refer to the Zebra Declaration of Conformity (DoC) for details of other country markings. This is available at www.zebra.com/doc.

Note¹: Europe includes: Austria, Belgium, Bulgaria, Croatia, Czech Republic, Cyprus, Denmark, Estonia, Finland, France, Germany, Greece, Hungary, Iceland, Ireland, Italy, Latvia, Liechtenstein, Lithuania, Luxembourg, Malta, Netherlands, Norway, Poland, Portugal, Romania, Slovak Republic, Slovenia, Spain, Sweden, Switzerland, and the United Kingdom.



CAUTION Operation of the device without regulatory approval is illegal.

Country Roaming

This device incorporates the International Roaming feature (IEEE802.11d) which will ensure the product operates on the correct channels for the particular country of use.

Wi-Fi Direct

Operation is limited to the following channels/bands as supported in the country of use:

- Channels 1-11 (2412 - 2462 MHz)
- Channels 36-48 (5150 - 5250 MHz)
- Channels 149-165 (5745 - 5825 MHz)

Frequency of Operation – FCC and IC

5 GHz Only

Industry Canada Statement:

Caution: The device for the band 5150-5250 MHz is only for indoor usage to reduce potential for harmful interference to co-Channel mobile satellite systems. High power radars are allocated as primary users (meaning they have priority) of 5250-5350 MHz and 5650-5850 MHz and these radars could cause interference and/or damage to LE-LAN devices.

Avertissement: Le dispositif fonctionnant dans la bande 5150-5250 MHz est réservé uniquement pour une utilisation à l'intérieur afin de réduire les risques de brouillage préjudiciable aux systèmes de satellites mobiles utilisant les mêmes canaux. Les utilisateurs de radars de haute puissance sont désignés utilisateurs principaux (c.-à-d., qu'ils ont la priorité) pour les bands 5250-5350 MHz et 5650-5850 MHz et que ces radars pourraient causer du brouillage et/ou des dommages aux dispositifs LAN-EL.

2.4 GHz Only

The available channels for 802.11 operation in the US are channels 1 to 11. The range of channels is limited by firmware.

Health and Safety Recommendations

Ergonomic Recommendations



CAUTION In order to avoid or minimize the potential risk of ergonomic injury, follow the recommendations below. Consult with your local Health & Safety Manager to ensure that you are adhering to your company's safety programs to prevent employee injury.

- Reduce or eliminate repetitive motion
- Maintain a natural position
- Reduce or eliminate excessive force
- Keep objects that are used frequently within easy reach
- Perform tasks at correct heights
- Reduce or eliminate vibration
- Reduce or eliminate direct pressure
- Provide adjustable workstations
- Provide adequate clearance
- Provide a suitable working environment
- Improve work procedures

Vehicle Installation

RF signals may affect improperly installed or inadequately shielded electronic systems in motor vehicles (including safety systems). Check with the manufacturer or its representative regarding your vehicle. You should also consult the manufacturer about any equipment that has been added to your vehicle.

An air bag inflates with great force. **DO NOT** place objects, including either installed or portable wireless equipment, in the area over the air bag or in the air bag deployment area. If in-vehicle wireless equipment is improperly installed and the air bag inflates, serious injury could result.

Position the device within easy reach to be able to access the device without removing your eyes from the road.

Note: Connection to an alert device that will cause a vehicle horn to sound or lights to flash on receipt of a call on public roads is not permitted.



IMPORTANT

Before installing or using, check state and local laws regarding windshield mounting and use of equipment.

For Safe installation

- Do not put your phone in a location that obstructs the drivers vision or interferes with the operation of the vehicle.
- Do not cover an airbag.

Safety on the Road

Do not take notes or use the device while driving. Jotting down a 'to do' list or flipping through your address book takes attention away from your primary responsibility; driving safely.

When driving a car, driving is your first responsibility. Give your full attention to driving. Check the laws and regulations on the use of wireless devices in the areas where you drive. Always obey them.

When using a wireless device behind the wheel of a car, practice good common sense and remember the following tips:

1. Get to know your wireless device and any features such as speed dial and redial. If available, these features help you to place your call without taking your attention off the road.
2. When available, use a hands-free device.
3. Let the person you are speaking with know you are driving; if necessary, suspend the call in heavy traffic or hazardous weather conditions. Rain, sleet, snow, ice, and even heavy traffic can be hazardous.
4. Dial sensibly and assess the traffic; if possible, place calls when you are not moving or before pulling into traffic. Try to plan calls when your car will be stationary. If you need to make a call while moving, dial only a few numbers, check the road and your mirrors, then continue.
5. Do not engage in stressful or emotional conversations that may be distracting. Make people you are talking with aware you are driving and suspend conversations that have the potential to divert your attention from the road.

6. Use your wireless phone to call for help. Dial the Emergency services (9-1-1 in the US, and 1-1-2 in Europe) or other local emergency number in the case of fire, traffic accident, or medical emergencies. Remember, it is a free call on your wireless phone. The call can be made regardless of any security codes and depending on a network; with or without a SIM card inserted.
7. Use your wireless phone to help others in emergencies. If you see an auto accident, crime in progress, or other serious emergency where lives are in danger, call the Emergency Services (9-1-1 in the US, and 1-1-2 in Europe) or other local emergency number as you would want others to do for you.
8. Call roadside assistance or a special non-emergency wireless assistance number when necessary. If you see a broken-down vehicle posing no serious hazard, a broken traffic signal, a minor traffic accident where no one appears injured, or a vehicle you know to be stolen, call roadside assistance or other special non-emergency wireless number.

The wireless industry reminds you to use your device/phone safely when driving.



Warnings for Use of Wireless Devices

Please observe all warning notices with regard to the usage of wireless devices.

Potentially Hazardous Atmospheres – Vehicles Use

You are reminded of the need to observe restrictions on the use of radio devices in fuel depots, chemical plants, etc., and areas where the air contains chemicals or particles such as grain, dust, or metal powders and any other area where you would normally be advised to turn off your vehicle engine.

Safety in Aircraft

Switch off your wireless device whenever you are instructed to do so by airport or airline staff. If your device offers a 'flight mode' or similar feature, consult airline staff as to its use in flight.



Safety in Hospitals

Wireless devices transmit radio frequency energy and may affect medical electrical equipment.

Wireless devices should be switched off wherever you are requested to do so in hospitals, clinics or healthcare facilities. These requests are designed to prevent possible interference with sensitive medical equipment.

Pacemakers

Pacemaker manufacturers recommended that a minimum of 15 cm (6 inches) be maintained between a handheld wireless device and a pacemaker to avoid potential interference with the pacemaker. These recommendations are consistent with independent research and recommendations by Wireless Technology Research.

Persons with pacemakers:

- Should ALWAYS keep the device more than 15cm (6 inches) from their pacemaker when turned ON.
- Should not carry the device in a breast pocket.
- Should use the ear furthest from the pacemaker to minimize the potential for interference.
- If you have any reason to suspect that interference is taking place, turn OFF your device.

Other Medical Devices

Please consult your physician or the manufacturer of the medical device, to determine if the operation of your wireless product may interfere with the medical device.



RF Exposure Guidelines

Safety Information

Reducing RF Exposure – Use Properly

Only operate the device in accordance with the instructions supplied.

International

The device complies with internationally recognized standards covering human exposure to electromagnetic fields from radio devices. For information on “International” human exposure to electromagnetic fields refer to the Zebra Declaration of Conformity (DoC) at www.zebra.com/doc.

For further information on the safety of RF energy from wireless devices, see www.zebra.com/responsibility located under Corporate Responsibility

Europe

Handheld Devices

This device was tested for typical body-worn operation. Use only Zebra tested and approved belt-clips, holsters, and similar accessories to ensure EU Compliance.

US

Co-located Statement

To comply with FCC RF exposure compliance requirement, the antenna used for this transmitter must not be co-located or operating in conjunction with any other transmitter/antenna except those already approved in this filling.

Handheld Devices

This device was tested for typical body-worn operation. Use only Zebra tested and approved belt-clips, holsters, and similar accessories to ensure FCC Compliance. The use of third-party belt-clips, holsters, and similar accessories may not comply with FCC RF exposure compliance requirements, and should be avoided.

This device was tested for typical handheld operation. The FCC has granted an Equipment Authorization for these model phones with all reported SAR levels evaluated as in compliance with the FCC RF exposure guidelines. SAR information on these model phones is on file with the FCC and can be found under the Display Grant section of <http://www.fcc.gov/oet/ea/fccid>.

The use of third-party accessories may not ensure compliance with FCC RF exposure requirements, and should be avoided.

Canada

This device was tested for typical handheld operation. The ISED has approved these model phones with all reported SAR levels evaluated as in compliance with the ISED RF exposure guidelines. SAR information on these model phones is on file with the ISED and can be found under the SAR Results section of <https://sms-sgs.ic.gc.ca/equipmentSearch/searchRadioEquipments>.

The use of third-party accessories may not ensure compliance with ISED RF exposure requirements, and should be avoided.

Cet appareil a été testé pour une opération manuelle typique. L'ISED a approuvé ces modèles de téléphones avec tous les niveaux SAR déclarés évalués conformément aux directives d'exposition RF ISED. L'information SAR sur ces modèles de téléphones est en mémoire avec l'ISED et peut être trouvée dans la

section Résultats SAR de

<https://sms-sgs.ic.gc.ca/equipmentSearch/searchRadioEquipements>.

L'utilisation d'accessoires tiers peut ne pas garantir la conformité aux exigences d'exposition RF ISED, et devrait être évitée.

To ensure compliance with ISED RF exposure requirement, the user shall keep the front of the RFID Device transmitting antenna at least 55 mm away from any bystander.

Laser Devices

Class 2 laser scanners use a low power, visible light diode. As with any very bright light source such as the sun, the user should avoid staring directly into the light beam. Momentary exposure to a Class 2 laser is not known to be harmful.



CAUTION Use of controls, adjustments, or the performance of procedures other than those specified herein may result in hazardous laser light exposure.

Scanner Labeling

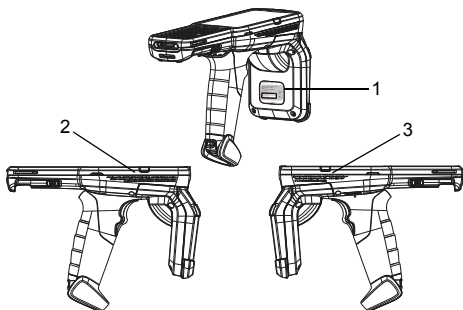

Labels Read:

1. LASER LIGHT - DO NOT STARE INTO BEAM.
2. CAUTION - CLASS 2 LASER LIGHT WHEN OPEN. DO NOT STARE INTO THE BEAM.
3. COMPLIES WITH 21CFR1040.10 and 1040.11 EXCEPT FOR DEVIATIONS PURSUANT TO LASER NOTICE NO. 50, DATED JUNE 24, 2007 and IEC/EN 60825-1:2014.

LED Devices

Classified as "EXEMPT RISK GROUP" according to IEC 62471:2006 and EN 62471:2008

Pulse duration: 1.7 ms for MC3300R with SE4750

Pulse duration: Continuous Wave for MC3300R with SE4850

Power Supply

Use ONLY a Zebra approved Nationally Recognized Test Laboratory (NRTL) Certified ITE (LPS/SELV) power supply with electrical ratings: Output 5 VDC, min 2.5 A, with a maximum ambient temperature of at least 50° C. Use of alternative power supply will invalidate any approvals given to this unit and may be dangerous.

Batteries

Taiwan - Recycling

EPA (Environmental Protection Administration) requires dry battery producing or importing firms in accordance with Article 15 of the Waste Disposal Act are required to indicate the recycling marks on the batteries used in sales, giveaway or promotion. Contact a qualified Taiwanese recycler for proper battery disposal.



「廢電池請回收」

Battery Information



CAUTION Risk of explosion if battery is replaced by an incorrect type. Dispose of batteries according to instructions.

Use only approved batteries. Accessories which have battery charging capability are approved for use with the following battery models:

- Model BT-000337 (3.7 Vdc, 5200 mAh)

Zebra approved rechargeable battery packs are designed and constructed to the highest standards within the industry.

However, there are limitations as to how long a battery can operate or be stored before needing replacement. Many factors affect the actual life cycle of a battery pack such as heat, cold, harsh environmental conditions, and severe drops.

When batteries are stored over six months, some irreversible deterioration in overall battery quality may occur. Store batteries at half of full charge in a dry, cool place, removed from the equipment to prevent loss of capacity, rusting of metallic parts, and electrolyte leakage. When storing batteries for one year or longer, the charge level should be verified at least once a year and charged to half of full charge.

Replace the battery when a significant loss of run time is detected.

Standard warranty period for all Zebra batteries is one year, regardless if the battery was purchased separately or included as part of the mobile computer or bar code scanner. For more information on Zebra batteries, please visit: www.zebra.com/batterybasics.

Battery Safety Guidelines

- The area in which the units are charged should be clear of debris and combustible materials or chemicals. Particular care should be taken where the device is charged in a non commercial environment.
- Follow battery usage, storage, and charging guidelines found in the user's guide.
- Improper battery use may result in a fire, explosion, or other hazard.
- To charge the mobile device battery, the battery and charger temperatures must be between +32 °F and +104°F (0°C and +40°C)
- Do not use incompatible batteries and chargers. Use of an incompatible battery or charger may present a risk of fire, explosion, leakage, or other hazard. If you have any questions about the compatibility of a battery or a charger, contact Zebra support.
- For devices that utilize a USB port as a charging source, the device shall only be connected to products that bear the USB-IF logo or have completed the USB-IF compliance program.
- Do not disassemble or open, crush, bend or deform, puncture, or shred.
- Severe impact from dropping any battery-operated device on a hard surface could cause the battery to overheat.
- Do not short circuit a battery or allow metallic or conductive objects to contact the battery terminals.
- Do not modify or remanufacture, attempt to insert foreign objects into the battery, immerse or expose to water or other liquids, or expose to fire, explosion, or other hazard.
- Do not leave or store the equipment in or near areas that might get very hot, such as in a parked vehicle or near a radiator or other heat source. Do not place battery into a microwave oven or dryer.
- Battery usage by children should be supervised.

- Please follow local regulations to promptly dispose of used re-chargeable batteries.
- Do not dispose of batteries in fire.
- Seek medical advice immediately if a battery has been swallowed.
- In the event of a battery leak, do not allow the liquid to come in contact with the skin or eyes. If contact has been made, wash the affected area with large amounts of water and seek medical advice.
- If you suspect damage to your equipment or battery, contact Zebra support to arrange for inspection.

Radio Frequency Interference Requirements - FCC

Note: This equipment has been tested and found to comply with the limits for a Class B digital device, pursuant to Part 15 of the FCC rules. These limits are designed to provide reasonable protection against harmful interference in a residential installation. This equipment generates, uses and can radiate radio frequency energy and, if not installed and used in accordance with the instructions, may cause harmful interference to radio communications. However there is no guarantee that interference will not occur in a particular installation. If this equipment does cause harmful interference to radio or television reception, which can be determined by turning the equipment off and on, the user is encouraged to try to correct the interference by one or more of the following measures:

- Reorient or relocate the receiving antenna
- Increase the separation between the equipment and receiver
- Connect the equipment into an outlet on a circuit different from that to which the receiver is connected
- Consult the dealer or an experienced radio/TV technician for help.

Radio Transmitters (Part 15)

This device complies with Part 15 of the FCC Rules. Operation is subject to the following two conditions: (1) this device may not cause harmful interference, and (2) this device must accept any interference received, including interference that may cause undesired operation.

Radio Frequency Interference Requirements - Canada

Innovation, Science and Economic Development Canada ICES-003 Compliance Label: CAN ICES-3 (B)/NMB-3(B)

Radio Transmitters

This device complies with Industry Canada's licence-exempt RSSs. Operation is subject to the following two conditions: (1) This device may not cause interference; and (2) This device must accept any interference, including interference that may cause undesired operation of the device.

Le présent appareil est conforme aux CNR d'Industrie Canada applicables aux appareils radio exempts de licence. L'exploitation est autorisée aux deux conditions suivantes: (1) l'appareil ne doit pas produire de brouillage, et (2) l'utilisateur de l'appareil doit accepter tout brouillage radio électrique subi même si le brouillage est susceptible d'en compromettre le fonctionnement.

Label Marking: The Term "IC:" before the radio certification only signifies that Industry Canada technical specifications were met.

Etiquette de marquage: Le terme "IC" avant la certification radio signifie que le produit est compatible avec la spécification Industrie Canada.

CE Marking and European Economic Area (EEA)

The use of 5GHz RLAN throughout the EEA has the following restriction:

- 5.15 - 5.35 GHz is restricted to indoor use only

Statement of Compliance

Zebra hereby declares that this radio equipment is in compliance with Directives 2014/53/EU and 2011/65/EU. The full text of the EU Declaration of Conformity may be obtained from www.zebra.com/doc.

Korea Warning Statement for Class B ITE

기종별	사용자안내문
B급 기기 (가정용 방송통신기자재)	이 기기는 가정용 (B 급) 전자파적합기기로서 주로 가정에서 사용하는 것을 목적으로 하며, 모든 지역에서 사용할 수 있습니다.

Other Countries

Australia

Use of 5 GHz RLAN in Australia is restricted in the following band 5.60–5.65 GHz.

Brazil

Declarações Regulamentares para MC3300R - Brasil

Nota: A marca de certificação se aplica ao Transceptor, mod MC3300R. Este equipamento não tem direito à proteção contra interferência prejudicial e não pode causar interferência em Sistemas devidamente autorizados.

Para maiores informações sobre ANATEL consulte o site: www.anatel.gov.br.

Este produto está homologado pela Anatel, de acordo com os procedimentos regulamentados pela Resolução n°242/2000 e atende aos requisitos técnicos aplicados, incluindo os limites de exposição da Taxa de Absorção Específica referente a campos elétricos, magnéticos e eletromagnéticos de radiofrequência, de acordo com as Resoluções n° 303/2002 e 533/2009.

Chile

Conforme a Resolución 755 parte j.1), se ajustará el dispositivo a operar en interiores en las siguientes bandas con una potencia máxima radiada no superior a 150mW:

2.400 a 2.483,5MHz

5.150 a 5.250MHz

5.250 a 5.350MHz

5.470 a 5.725MHz

5.725 a 5.850MHz

Además, de acuerdo con Resolución 755, para la banda 5.150 a 5.250 MHz la operación del equipo estará restringida al interior de inmuebles y la densidad de potencia radiada máxima no excederá 7,5mW/MHz en cualquier banda de 1MHz o su valor equivalente de 0,1875mW/25 kHz en cualquier banda de 25 kHz.

Para la función UHF RFID, se ajustará el dispositivo a operar en el interior de inmuebles en la banda de 915 a 928 MHz con una potencia máxima radiada no superior a 100 mW, conforme a Resolución 755 parte Art 1. j3).

China

通过访问以下网址可下载当地语言支持的产品说明书

www.zebra.com/support

锂电池安全警示语：

警告：请勿拆装，短路，撞击，挤压或者投入火中

注意：如果电池被不正确型号替换，或出现鼓胀，会存在爆炸及其他危险

请按说明处置使用过的电池

电池浸水后严禁使用

合格证：



Eurasian Customs Union

Евразийский Таможенный Союз

Данный продукт соответствует требованиям знака ЕАС.



Hong Kong

In accordance with HKTA1039, the band 5.15 GHz - 5.35 GHz is for indoor operation only.

Mexico

La operación de este equipo está sujeta a las siguientes dos condiciones: (1) es posible que este equipo o dispositivo no cause interferencia perjudicial y (2) este equipo o dispositivo debe aceptar cualquier interferencia, incluyendo la que pueda causar su operación no deseada.

South Korea

해당 무선설비는 운용 중 전파혼신 가능성이 있음

해당 무선설비는 전파혼신 가능성이 있으므로 인명안전과 관련된 서비스는 할 수 없습니다

Taiwan

臺灣

低功率電波輻射性電機管理辦法

第十二條

經型式認證合格之低功率射頻電機，非經許可，公司、商號或使用者均不得擅自變更頻率、加大功率或變更原設計之特性及功能。

第十四條

低功率射頻電機之使用不得影響飛航安全及干擾合法通信；經發現有干擾現象時，應立即停用，並改善至無干擾時方得繼續使用。

前項合法通信，指依電信法規定作業之無線電通信。

低功率射頻電機須忍受合法通信或工業、科學及醫療用電波輻射性電機設備之干擾。

應避免影響附近雷達系統之操作

公司資訊

台灣斑馬科技股份有限公司 / 台北市信義區松高路 9 號 13 樓

Ukraine

Дане обладнання відповідає вимогам технічного регламенту №1057, № 2008 на обмеження щодо використання деяких небезпечних речовин в електричних та електронних пристроях.

Thailand

เครื่องโทรคมนาคมและอุปกรณ์ นี้ มี ความสอดคล้อง องตามขั้ อกำหนดของ กทพ .

TURKISH WEEE Statement of Compliance

EEE Yönetmeliğine Uygundur



Waste Electrical and Electronic Equipment (WEEE)

English: For EU Customers: All products at the end of their life must be returned to Zebra for recycling. For information on how to return product, please go to: www.zebra.com/weee.

Français: Clients de l'Union Européenne: Tous les produits en fin de cycle de vie doivent être retournés à Zebra pour recyclage. Pour de plus amples informations sur le retour de produits, consultez : www.zebra.com/weee.

Español: Para clientes en la Unión Europea: todos los productos deberán entregarse a Zebra al final de su ciclo de vida para que sean reciclados. Si desea más información sobre cómo devolver un producto, visite: www.zebra.com/weee.

Български: За клиенти от ЕС: След края на полезния им живот всички продукти трябва да се връщат на Zebra за рециклиране. За информация относно връщането на продукти, моля отидете на адрес: www.zebra.com/weee.

Deutsch: Für Kunden innerhalb der EU: Alle Produkte müssen am Ende ihrer Lebensdauer zum Recycling an Zebra zurückgesandt werden. Informationen zur Rücksendung von Produkten finden Sie unter www.zebra.com/weee.

Italiano: per i clienti dell'UE: tutti i prodotti che sono giunti al termine del rispettivo ciclo di vita devono essere restituiti a Zebra al fine di consentirne il riciclaggio. Per informazioni sulle modalità di restituzione, visitare il seguente sito Web: www.zebra.com/weee.

Português: Para clientes da UE: todos os produtos no fim de vida devem ser devolvidos à Zebra para reciclagem. Para obter informações sobre como devolver o produto, visite: www.zebra.com/weee.

Nederlands: Voor klanten in de EU: alle producten dienen aan het einde van hun levensduur naar Zebra te worden teruggezonden voor recycling. Raadpleeg www.zebra.com/weee voor meer informatie over het terugzenden van producten.

Polski: Klienci z obszaru Unii Europejskiej: Produkty wycofane z eksploatacji należy zwrócić do firmy Zebra w celu ich utylizacji. Informacje na temat zwrotu produktów znajdują się na stronie internetowej www.zebra.com/weee.

Čeština: Pro zákazníky z EU: Všechny produkty je nutné po skončení jejich životnosti vrátit společnosti Zebra k recyklaci. Informace o způsobu vrácení produktu najdete na webové stránce: www.zebra.com/weee.

Eesti: EL klientidele: kõik tooted tuleb nende eluea lõppedes tagastada taaskasutamise eesmärgil Zebra'ile. Lisainformatsiooni saamiseks toote tagastamise kohta külastage palun aadressi: www.zebra.com/weee.

Magyar: Az EU-ban vásárlóknak: Minden tönkrement termékét a Zebra vállalathoz kell eljuttatni újrahasznosítás céljából. A termék visszajuttatásának módjával kapcsolatos tudnivalóért látogasson el a www.zebra.com/weee weboldalra.

Svenska: För kunder inom EU: Alla produkter som uppnått sin livslängd måste returneras till Zebra för återvinning. Information om hur du returnerar produkten finns på www.zebra.com/weee.

Suomi: Asiakkaat Euroopan unionin alueella: Kaikki tuotteet on palautettava kierrätettäväksi Zebra-yhtiöön, kun tuotetta ei enää käytetä. Lisätietoja tuotteen palauttamisesta on osoitteessa www.zebra.com/weee.

Dansk: Til kunder i EU: Alle produkter skal returneres til Zebra til recirkulering, når de er udtjent. Læs oplysningerne om returnering af produkter på: www.zebra.com/weee.

Ελληνικά: Για πελάτες στην Ε.Ε.: Όλα τα προϊόντα, στο τέλος της διάρκειας ζωής τους, πρέπει να επιστρέφονται στην Zebra για ανακύκλωση. Για περισσότερες πληροφορίες σχετικά με την επιστροφή ενός προϊόντος, επισκεφθείτε τη διεύθυνση www.zebra.com/weee στο Διαδίκτυο.

Malti: Għal klijenti fl-UE: il-prodotti kollha li jkunu waslu fl-aħħar tal-ħajja ta' l-użu tagħhom, iridu jiġu rritornati għand Zebra għar-riciklaġġ. Għal aktar taġġir dwar kif għandek tiritorna l-prodott, jekk jogħġbok żur: www.zebra.com/weee.

Românesc: Pentru clienții din UE: Toate produsele, la sfârșitul duratei lor de funcționare, trebuie returnate la Zebra pentru reciclare. Pentru informații despre returnarea produsului, accesați: www.zebra.com/weee.

Slovenski: Za kupce v EU: vsi izdelki se morajo po poteku življenjske dobe vrniti podjetju Zebra za reciklažo. Za informacije o vračilu izdelka obiščite: www.zebra.com/weee.

Slovenčina: Pre zákazníkov z krajín EU: Všetky výrobky musia byť po uplynutí doby ich životnosti vrátené spoločnosti Zebra na recykláciu. Bližšie informácie o vrátení výrobkov nájdete na: www.zebra.com/weee.

Lietuvių: ES vartotojams: visi gaminiai, pasibaigus jų eksploatacijos laikui, turi būti gražinti utilizuoti į kompaniją „Zebra“. Daugiau informacijos, kaip gražinti gaminį, rasite: www.zebra.com/weee.

Latviešu: ES klientiem: visi produkti pēc to kalpošanas mūža beigām ir jānogādā atpakaļ Zebra otrreizējai pārstrādei. Lai iegūtu informāciju par produktu nogādāšanu Zebra, lūdzu, skatiet: www.zebra.com/weee.

Türkçe: AB Müşterileri için: Kullanım süresi dolan tüm ürünler geri dönüşürme için Zebra'ya iade edilmelidir. Ürünlerin nasıl iade edileceği hakkında bilgi için lütfen şu adresi ziyaret edin: www.zebra.com/weee.

CMM Disclosure

This table was created to comply with China RoHS requirements.

部件名称 (Parts)	有害物质					
	铅 (Pb)	汞 (Hg)	镉 (Cd)	六价铬 (Cr(VI))	多溴联苯 (PBB)	多溴二苯醚 (PBDE)
金属部件 (Metal Parts)	X	O	O	O	O	O
电路模块 (Circuit Modules)	X	O	O	O	O	O
电缆及电缆组件 (Cables and Cable Assemblies)	O	O	O	O	O	O
塑料和聚合物部件 (Plastic and Polymeric Parts)	O	O	O	O	O	O
光学和光学组件 (Optics and Optical Components)	X	O	O	O	O	O
电池 (Batteries)	X	O	O	O	O	O



本表格依据SJ/T 11364 的规定编制。

O: 表示该有害物质在该部件所有均质材料中的含量均在 GB/T 26572 规定的限量要求以下。

X: 表示该有害物质至少在该部件的某一均质材料中的含量超出GB/T 26572 规定的限量要求。
(企业可在此处, 根据实际情况对上表中打“x”的技术原因进行进一步说明。)

限用物質含有情況標示聲明書

設備名稱：移動式電腦 Equipment name		型號（型式）：MC3300R Type designation (Type)				
單元 Unit	限用物質及其化學符號 Restricted substances and its chemical symbols					
	鉛 (Pb)	汞 (Hg)	鎘 (Cd)	六價鉻 (Cr ⁺⁶)	多溴聯苯 (PBB)	多溴二苯醚 (PBDE)
印刷電路板及電子組件	-	○	○	○	○	○
金屬零件	-	○	○	○	○	○
電纜及電纜組件	○	○	○	○	○	○
塑料和聚合物零件	○	○	○	○	○	○
光學與光學元件	-	○	○	○	○	○

備考1. “超出0.1 wt %”及“超出0.01 wt %”係指限用物質之百分比含量超出百分比含量基準值。

Note 1: “Exceeding 0.1 wt%” and “exceeding 0.01 wt%” indicate that the percentage content of the restricted substance exceeds the reference percentage value of presence condition.

備考2. “○”係指該項限用物質之百分比含量未超出百分比含量基準值。

Note 2: “○” indicates that the percentage content of the restricted substance does not exceed the percentage of reference value of presence.

備考3. “-”係指該項限用物質為排除項目。

Note 3: The “-” indicates that the restricted substance corresponds to the exemption.



www.zebra.com

© 2018 ZIH Corp and/or its affiliates. All rights reserved. Zebra and the stylized Zebra head are trademarks of ZIH Corp., registered in many jurisdictions worldwide. All other trademarks are the property of their respective owners.



MN-003182-01 Rev. B - 9/18